

# SOT-23 Package Outline

Package Outline Dimensions (Units: mm)

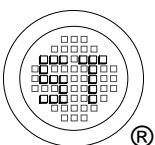

**SEMTECH ELECTRONICS LTD.**  
Subsidiary of Sino-Tech International (BVI) Limited

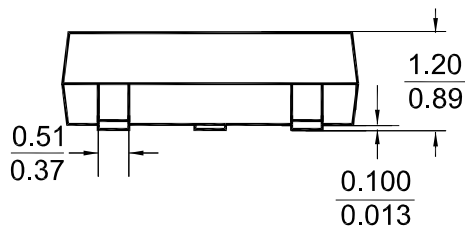
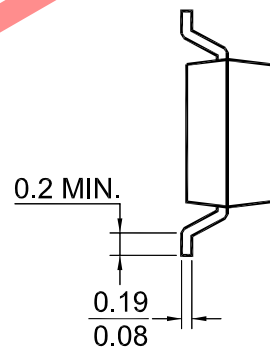
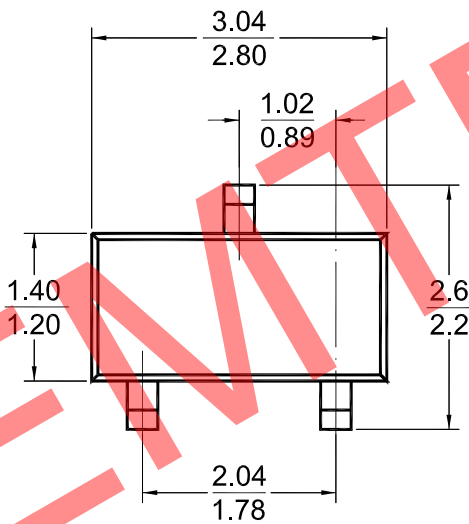
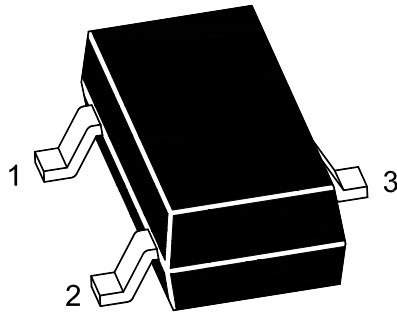

Dated : 23/10/2010 Rev:01